



# TVARUMO GALIA: KAIP KURIAME TVARIĄ RYTDIENĄ

Andrius Kurganovas

2025

# KAS MES ESAME?



Kepykla Biržuose  
423 darbuotojai  
250 + gaminių  
7200 t produkcijos per metus



23 firminės parduotuvės  
Visoje Lietuvoje  
3 - franšizės

# 2015 – įsidiegėme šilumos antrinio panaudojimo sistemą „Econova“



# Integracija įmonės katilinėje

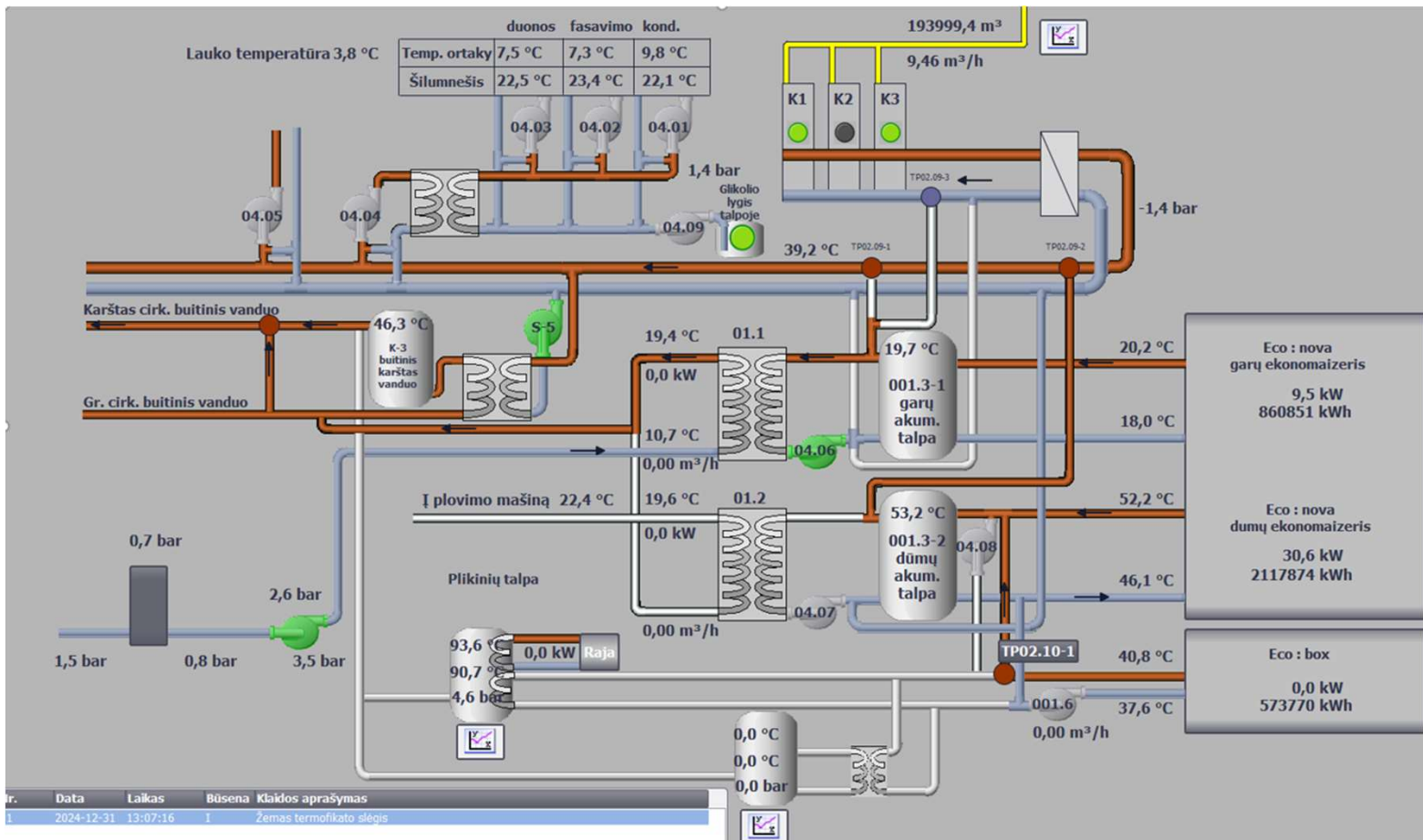



## Per 2024 metus sugeneruota vertės už 30 000 Eur

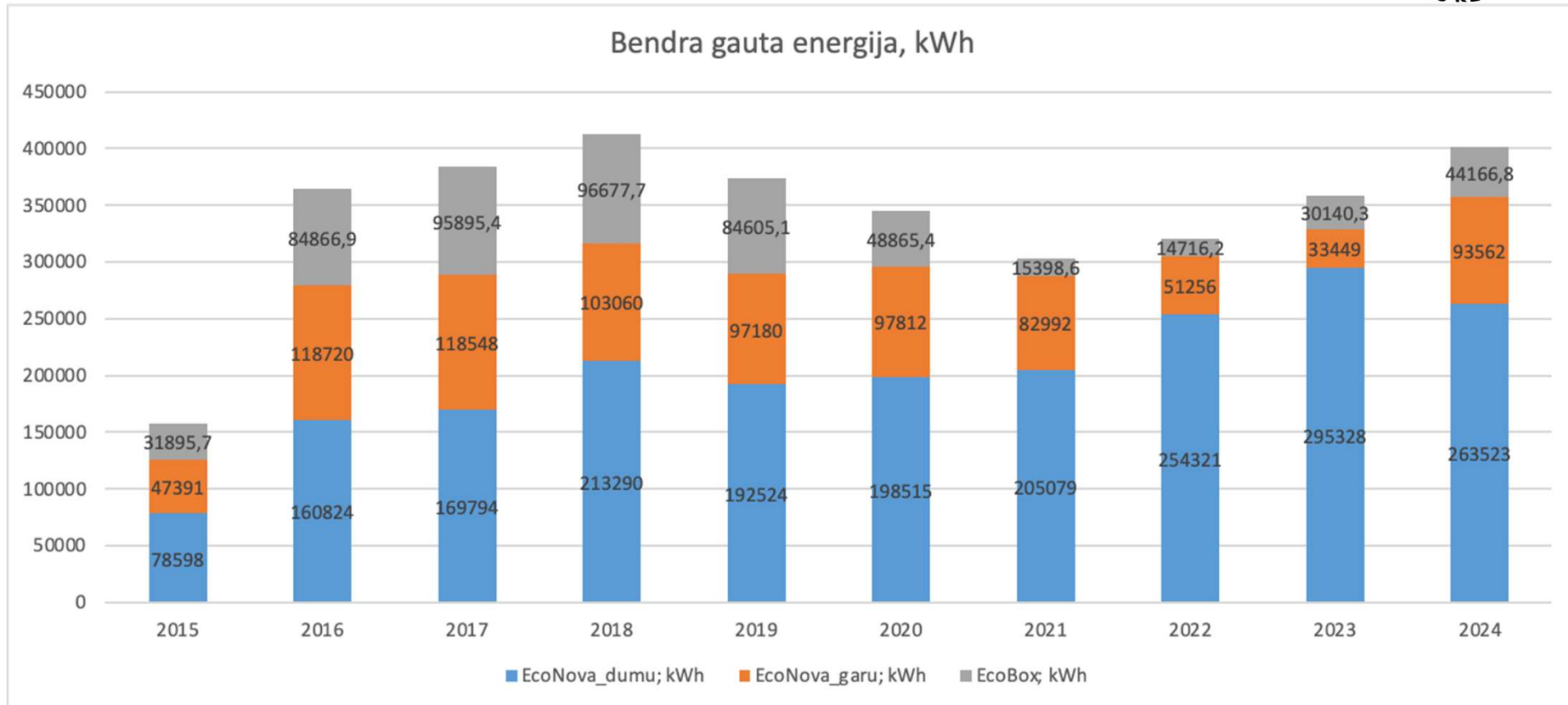

2020 – įsirengėme 450kW saulės jėgainę





Rating chart using a sunny summer day as an example

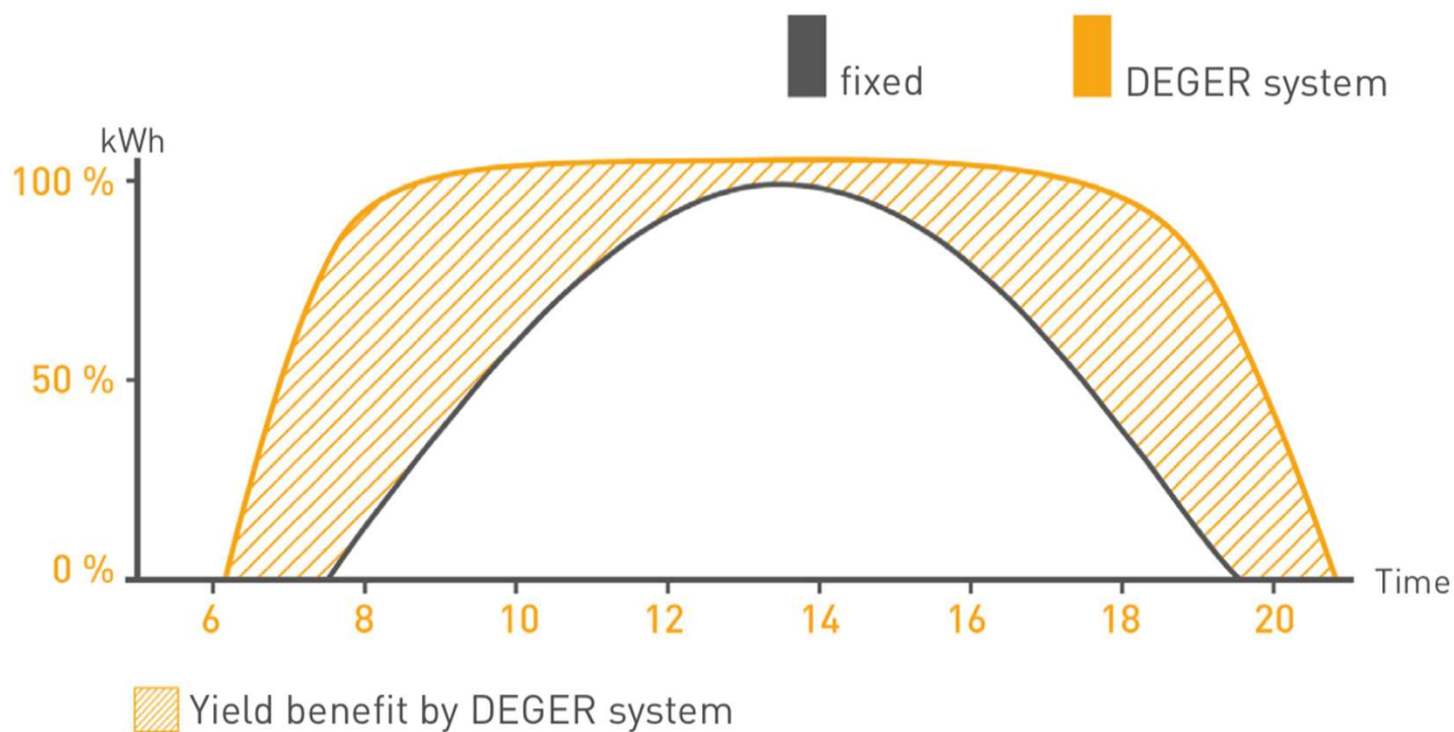

Šaltinis: <https://www.degerenergie.de/products/deger-tracker-single-axis/>

# VIENAŠĖ MODULIŲ SISTEMA

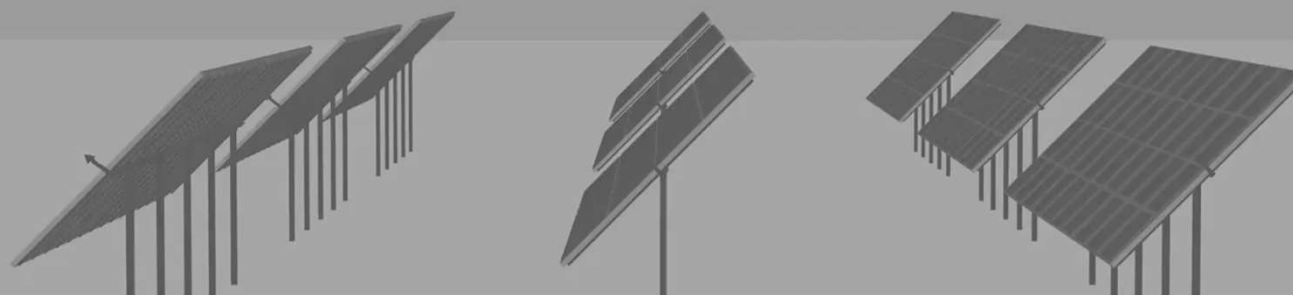

Šaltinis: <https://www.degerenergie.de/products/deger-tracker-single-axis/>



# DVIAŠĖ MODULIŲ SISTEMA

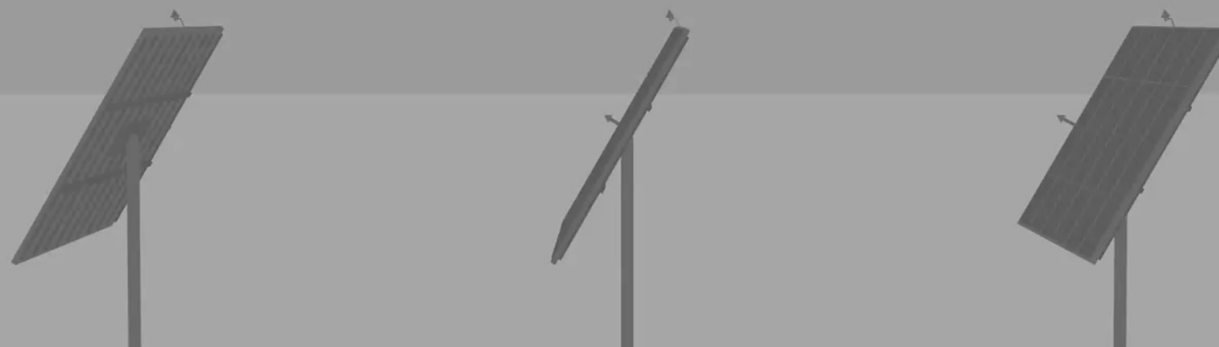

Šaltinis: <https://www.degerenergie.de/products/deger-tracker-dual-axis/>

**21 VIENAŠĖ SISTEMA  
12 DVIAŠIŲ SISTEMŲ**





# SUGENERUOTA VERTĖS 467 342 Eur



| Metai | Sugeneruota energijos, MWh | Suvaltota įmonėje, MWh | Suvaltota iš ESO, MWh | Suvaltota viso, MWh | Padengė viso, % | Saulės jėgainės sugeneruota už, Eur. |
|-------|----------------------------|------------------------|-----------------------|---------------------|-----------------|--------------------------------------|
| 2020  | 574,102                    | 486,213                | 1 334,70              | 1 820,91            | 32 %            | €45 496,58                           |
| 2021  | 555,872                    | 493,547                | 1 462,30              | 1 955,85            | 28 %            | €73 158,30                           |
| 2022  | 580,977                    | 534,987                | 1 614,08              | 2 149,07            | 27 %            | €181 023,75                          |
| 2023  | 576,521                    | 540,942                | 1 550,16              | 2 091,10            | 28 %            | €86 038,38                           |
| 2024  | 568,516                    | 544,021                | 1 566,49              | 2 110,51            | 27 %            | €81 625,36                           |
|       |                            |                        |                       |                     |                 | €467 342,37                          |

# BITYNAS - PUOSELĖTI EKOSISTEMĄ



# Meno instaliacija. Autorė Agnė Kišonaitė

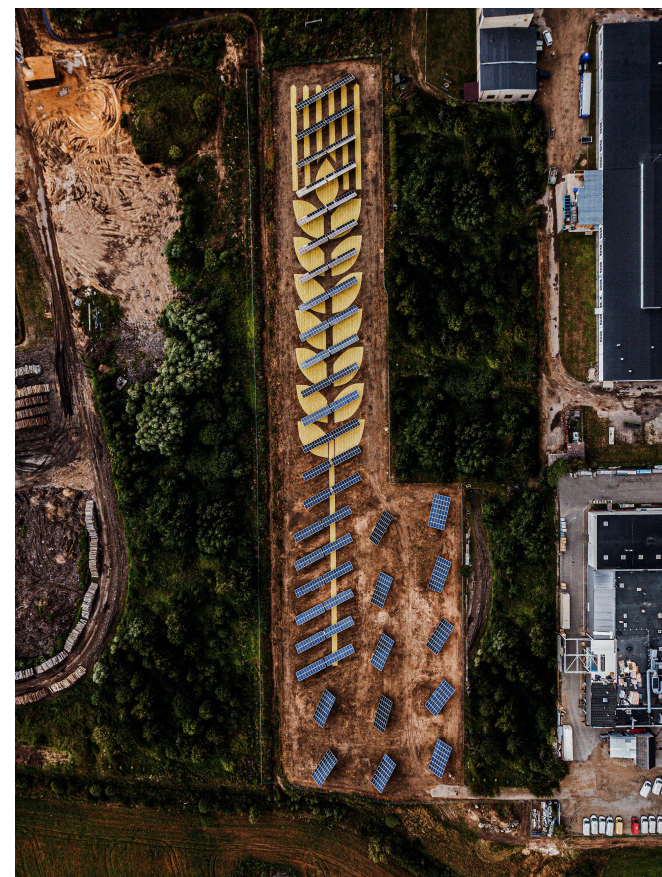

# 540 kW nauja saulės elektrinė 2025 07 31



# 2018 LED apšvietimas 64 % mažiau elektros energijos





**2016 – lentynos standarto neatitinkančius gaminius pradėjome naudoti antrą kartą**

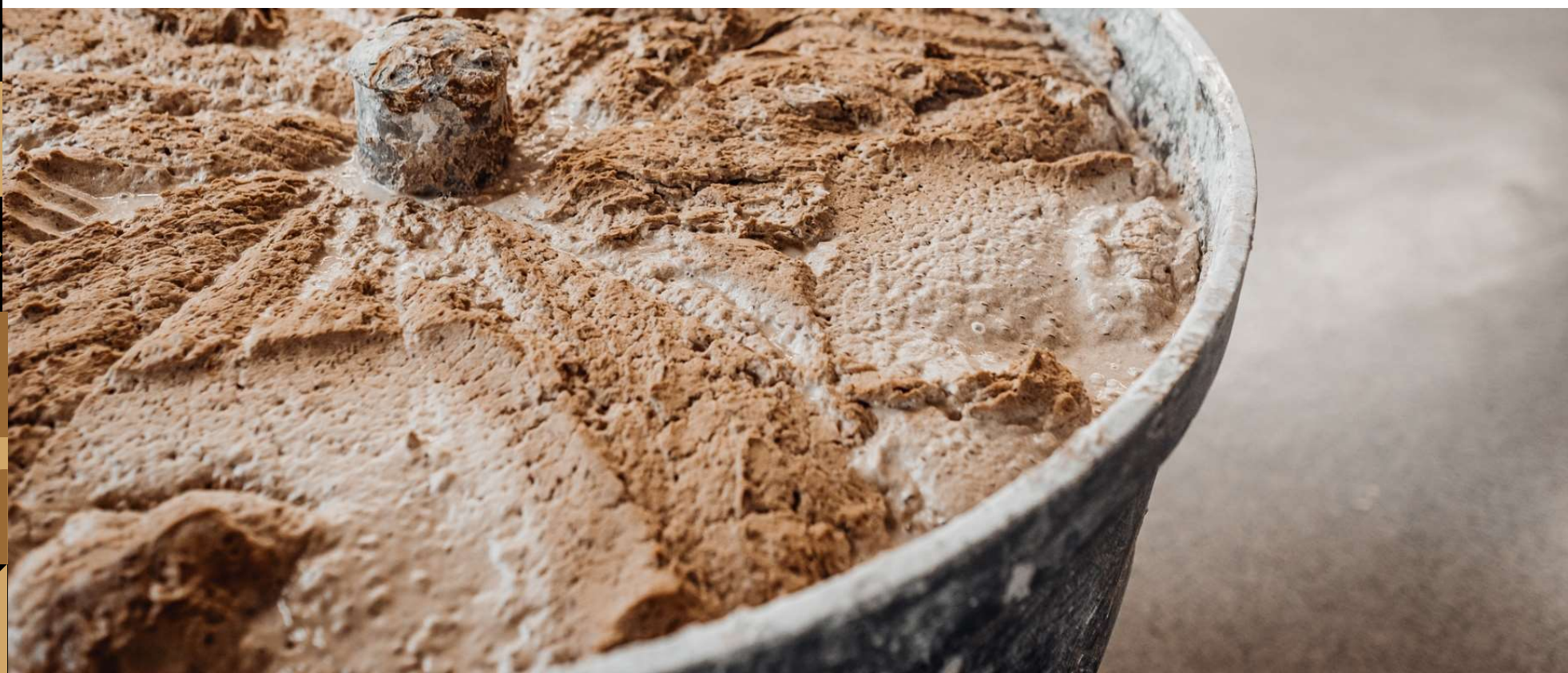

# 2019 – įrengėme atskirą cechą, skirtą gaminiams be glitimo



2019 – pradėjome gaminti duonos granolą ir kitus gaminius naudojant standarto neatitinkančią duoną

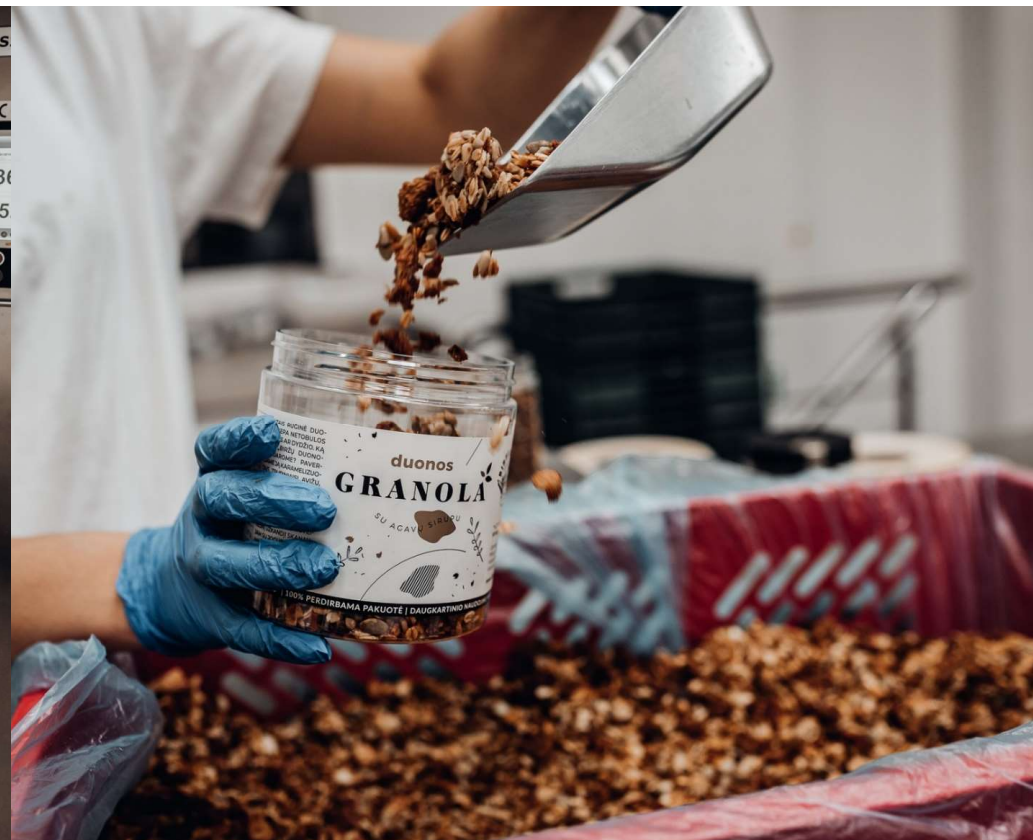

# 2020 – pilnai atsisakėme narvuose laikomų vištų kiaušinių



**2023 – paskelbėme savo pirmąją  
tvarumo ataskaitą už 2022 metus**

The background of the title is an aerial photograph of a forest. The left side shows a dense green forest, while the right side shows a cleared area with brown soil. Several solar panels are overlaid on the cleared area, arranged in a pattern that suggests a transition from nature to renewable energy.

# **TVARUMO ATASKAITA**

# Mūsų įvertinimai



\*Sustainable Brand Index™ 2021, 2022, 2023, 2024 m. vartotojų tyrimų duomenimis.

# 3 PATARIMAI JŪSŲ TVARUMO KELIONEI:

- Tvarumas – kasdienė jūsų veiklos dalis;
- Tvarumas kiekvienoje įmonėje atrodo skirtingai;
- Pradėkite ir nuo mažiausio žingsnelio – kiekvienas pokytis yra svarbus.





**AČIŪ!**

Daugiau mūsų tvarumo veiklų ataskaitoje:  
[birzuduona.lt/tvarumas](http://birzuduona.lt/tvarumas)

2025